

コイン形二酸化マンガンリチウム電池  
Coin manganese dioxide lithium batteries

# CR1220

■外形寸法 Dimensions(mm)

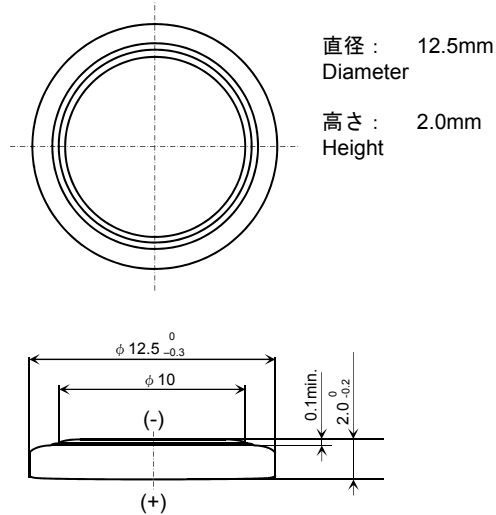

■定格 Specifications

公称電圧 <b>Nominal Voltage</b>	3 V
公称容量 (終止電圧 2.0V) <b>Nominal Capacity ( 2.0V cutoff)</b>	40 mAh
標準放電電流値 <b>Standard Discharge Current</b>	0.1 mA
標準質量 <b>Weight</b>	0.77 g
使用温度範囲 <b>Operating Temperature</b>	-30 ~ +70°C

用途 Applications

- 時計
- 電子手帳・電卓
- SRAMやリアルタイムクロック等メモリーバックアップ
- Electronic Watch or Clock
- Electronic Calculator
- Memory Back-up Power Source for SRAM or Real Time Clock (RTC)

■放電特性 Discharge Characteristics

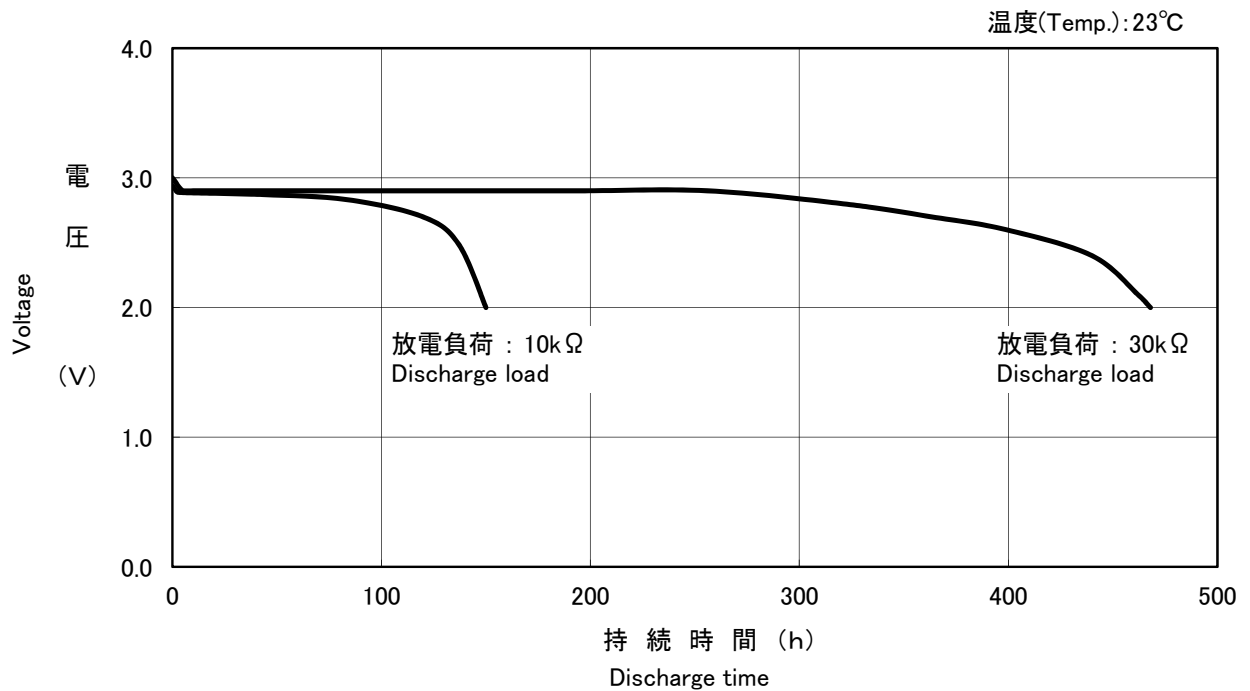

**■放電負荷特性**

Discharge Characteristics on Load

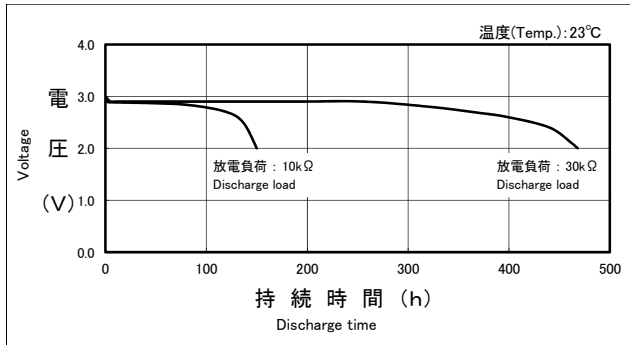

**■放電温度特性**

Discharge Characteristics on Temperature

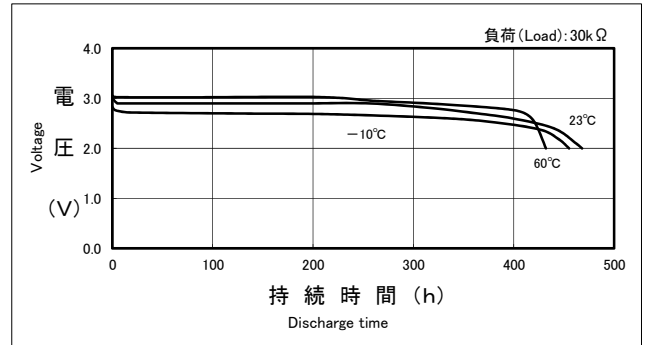

**■放電負荷と作動電圧（放電深度 40%時の電圧）**

Discharge Load vs. Operation Voltage (Discharge depth 40%)

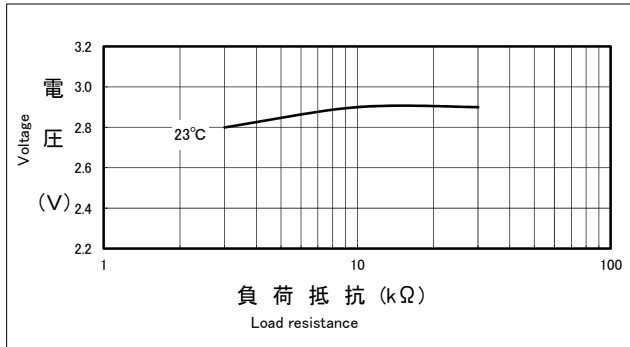

**■放電負荷と電気容量**

Discharge Load vs. Discharge Capacity

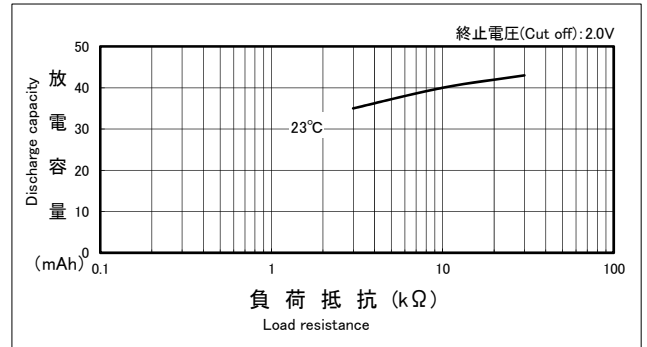

**■パルス放電特性（放電深度 40%時のパルス電圧）**

Discharge Characteristics on Pulse Load (Discharge depth 40%)

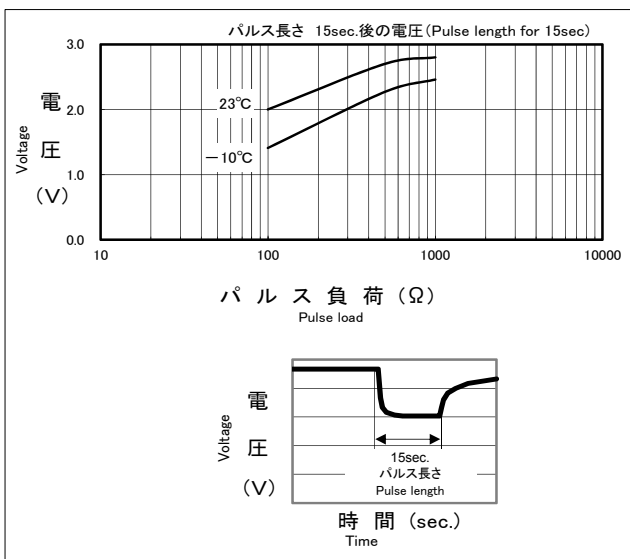

**■保存特性**

Storage Characteristics

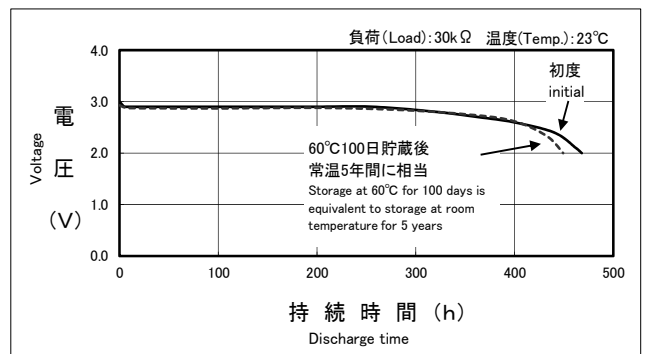

\*記載のデータ及び数値は、参考値であり保証値ではありません。

\*Data is not guaranteed, and is provided for reference purposes only.